

ASSEMBLY INSTRUCTIONS

5 DRAWER CHEST

Approximate Assembly Time



People Required to Assemble



Tools Required



Before you start...

Please carefully unpack and lay out all of the component parts to ensure nothing is missing and to check each component for any obvious damage.

Should you identify any concerns at this stage please contact the retailer from whom this product was purchased. Please quote your order number, details of your issue, the product code, and the batch number from the cartons which will help to resolve your issue as quickly as possible.

Version number - 1.0

Product Code - LOW053

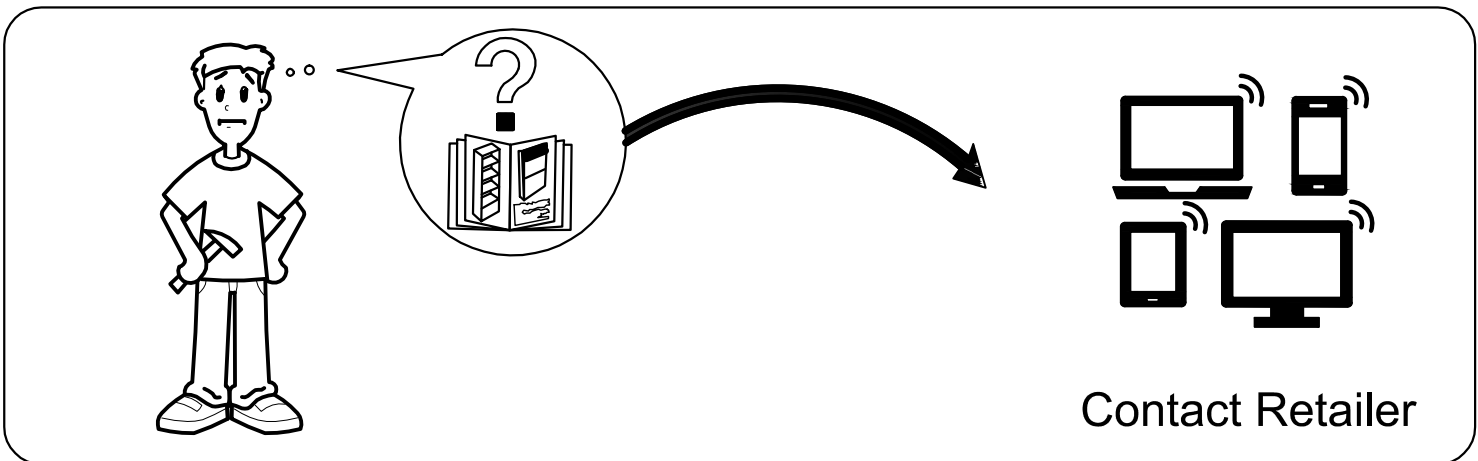
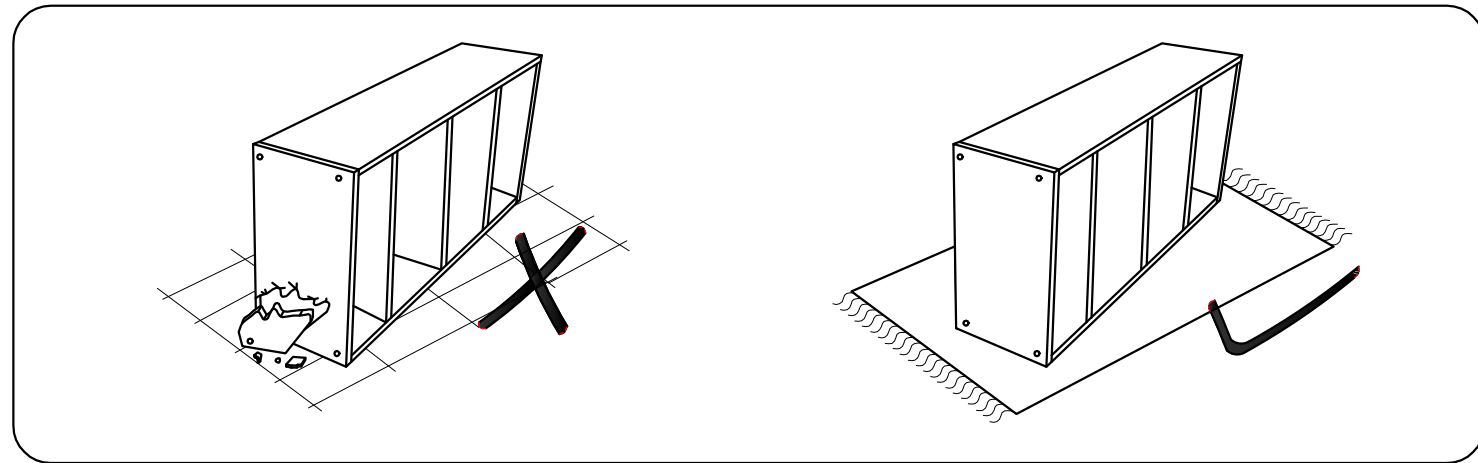
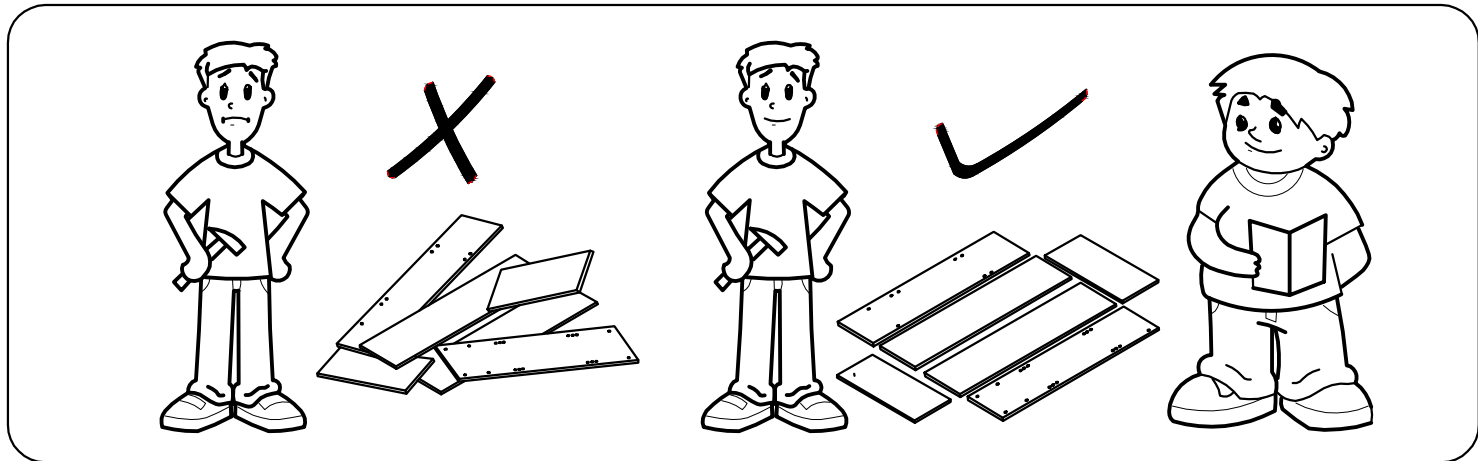
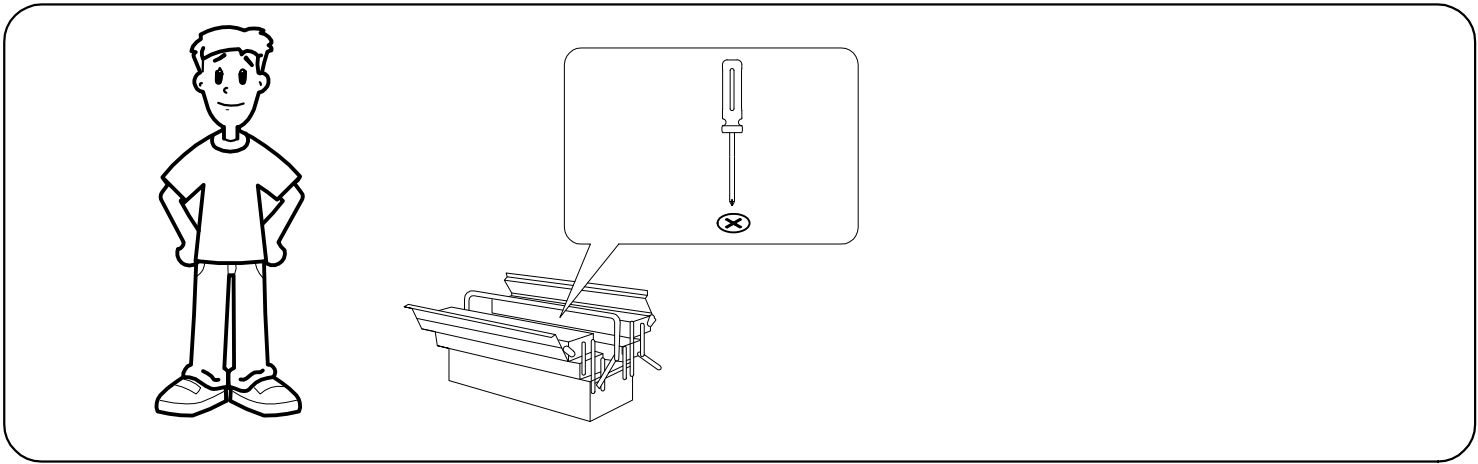

Please check all hardware matches the list below Should you notice any are missing please contact your retailer

A



8x M6x80

B



8x φ 6

C



8x φ 6

D



1x M4

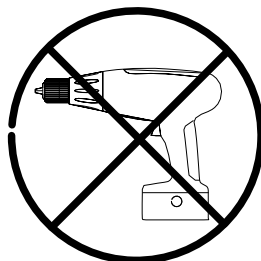

We strongly advise that you do not use Power Tools, such as drills or electric screwdrivers during the assembly as this may cause irreparable damage and will invalidate your warranty.

PARTS

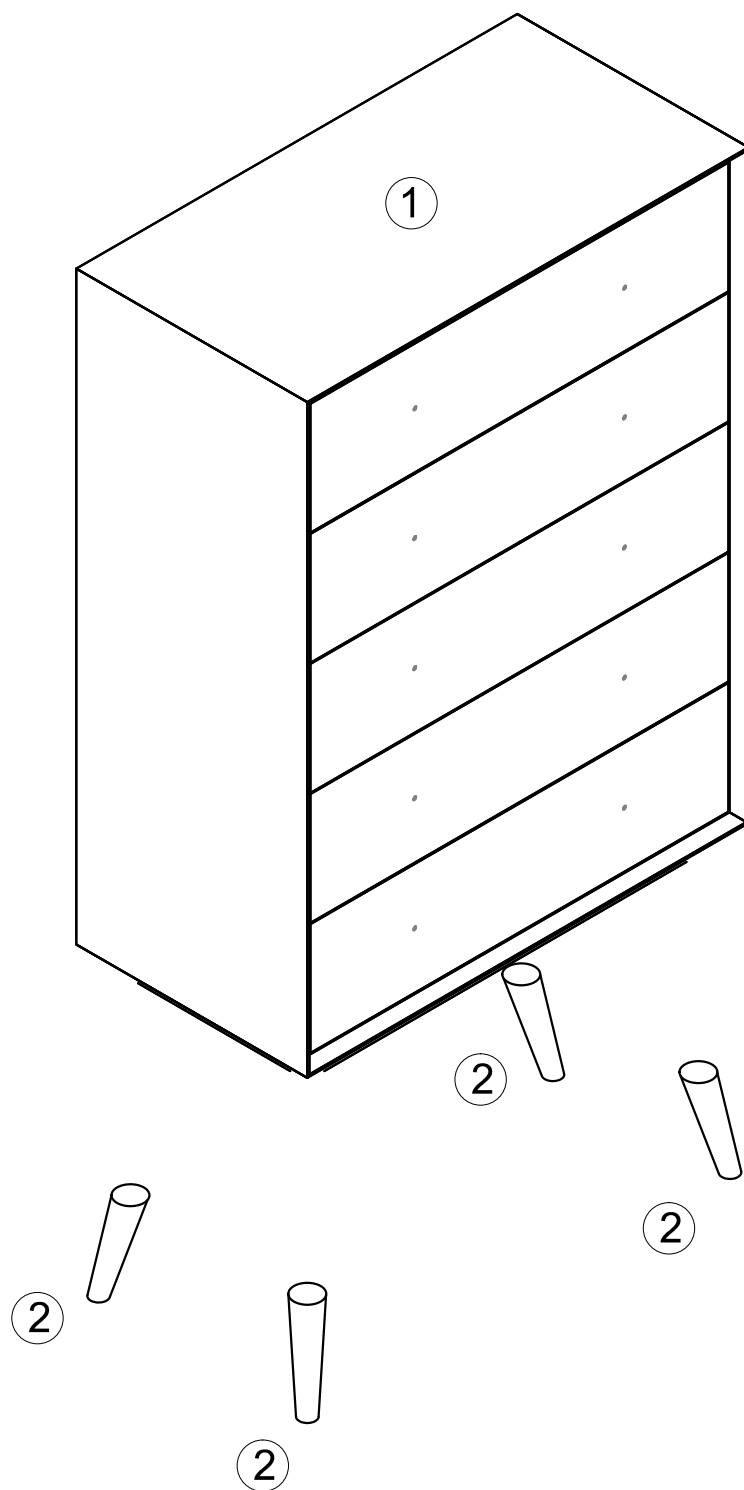

Please ensure you carefully check all the pieces, should you have any concerns please contact the retailer before assembly commences. Please have your order number, details of the issue, the product code, and the batch number from the cartons as this will help us to resolve your issue much faster.

ASSEMBLY ADVICE

Please take the time to carefully read through these instructions before you commence.

Keep these instructions for future reference.

We advise that the product is assembled in the room it is intended for.

We advise that you keep the hardware in a bowl during assembly to avoid losing anything.

We strongly recommend that you keep children away from the work area.

Small component parts could choke a child if swallowed.

We recommend you use a sheet or blanket to protect both floor and product through the assembly stages.

This product is heavy, and we recommend a 2 person lift to avoid personal injury or damage to the product.

Never push or pull the product as this could cause both personal injury or irreparable damage to product or floor.

We have tried to make this piece of furniture easy to assemble if the instructions are followed carefully.

In the unlikely event that you have problems with assembling the product or have missing or damaged parts, please contact your retailer and we will assist them in rectifying the problem as quickly as possible.



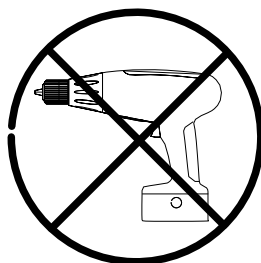

Please remember we strongly urge you DO NOT use power tools such as drill or electric screwdrivers as this could cause irreparable damage to your product and will invalidate your warranty.

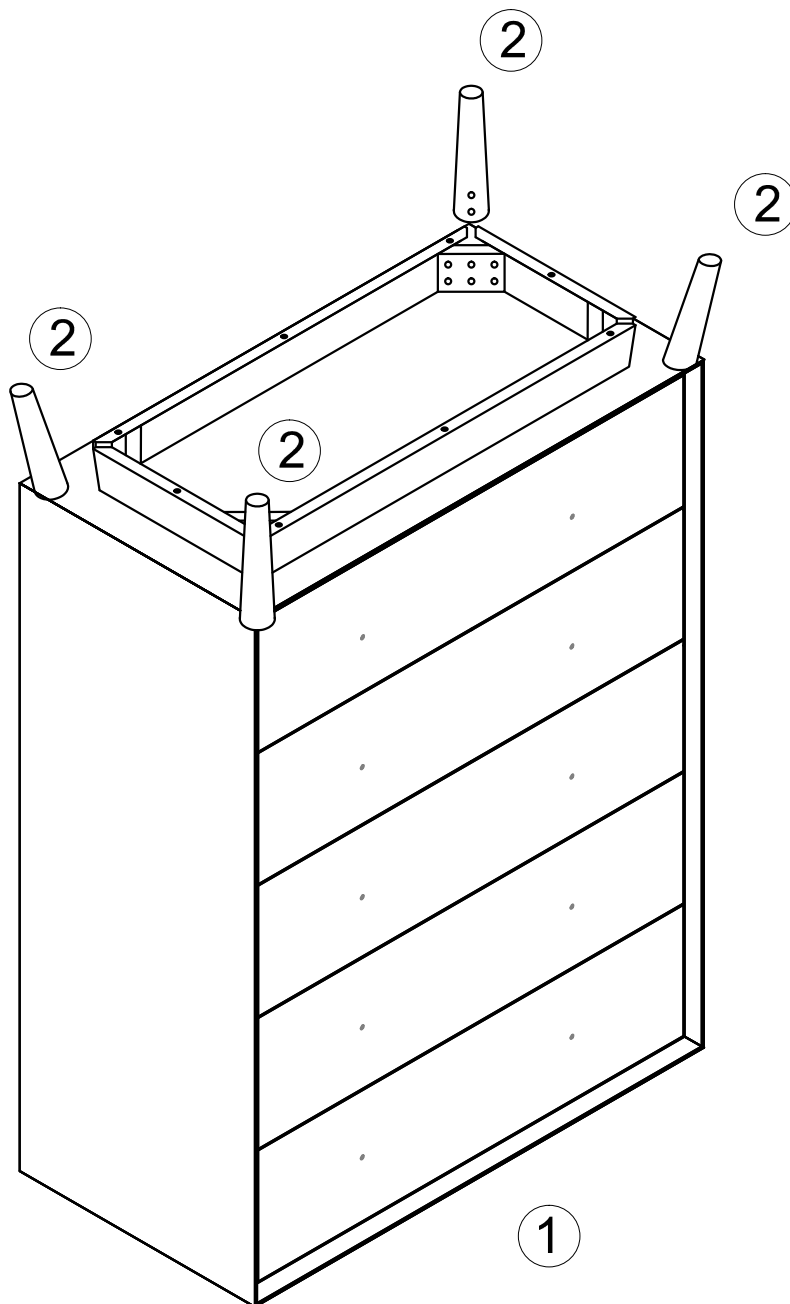
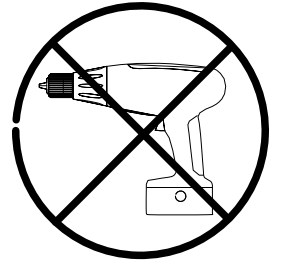

1



2

M6*80	φ 6	φ 6	M4 x1
 A	 B	 C	 D
x 8	x 8	x 8	x 1

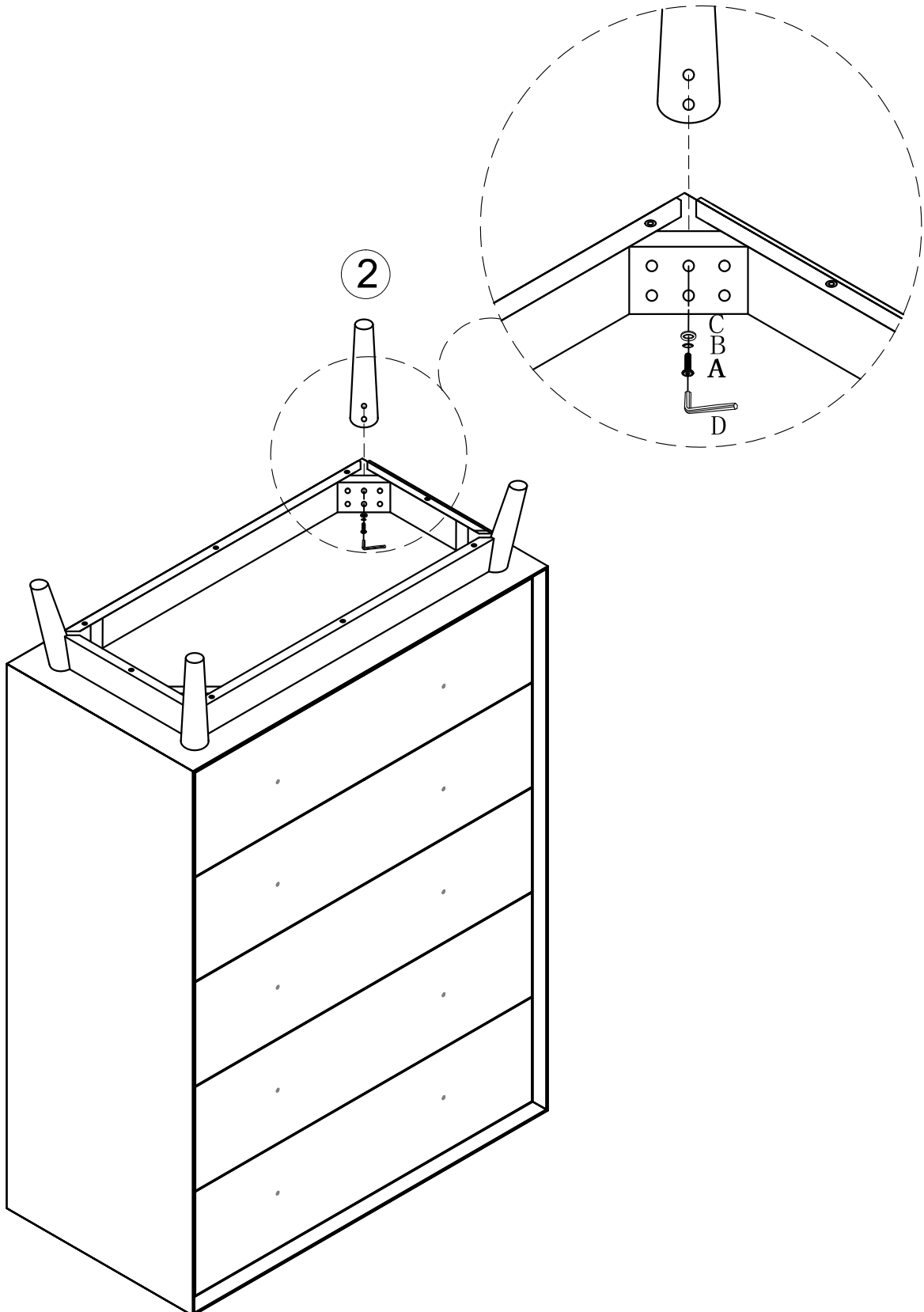
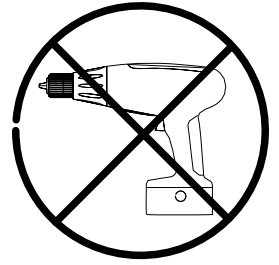

3

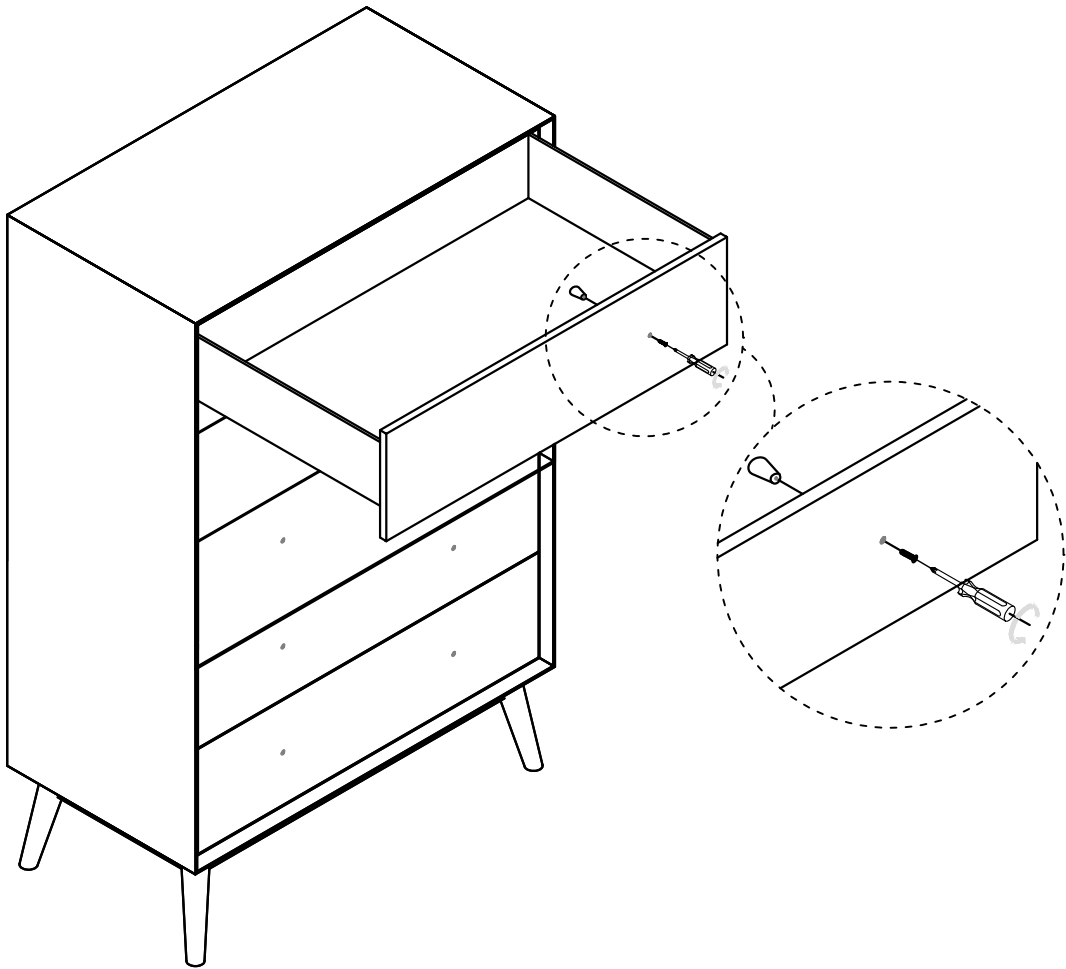
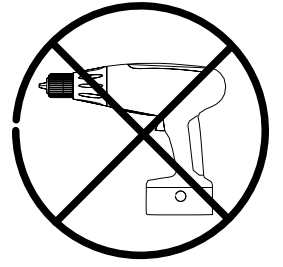

4

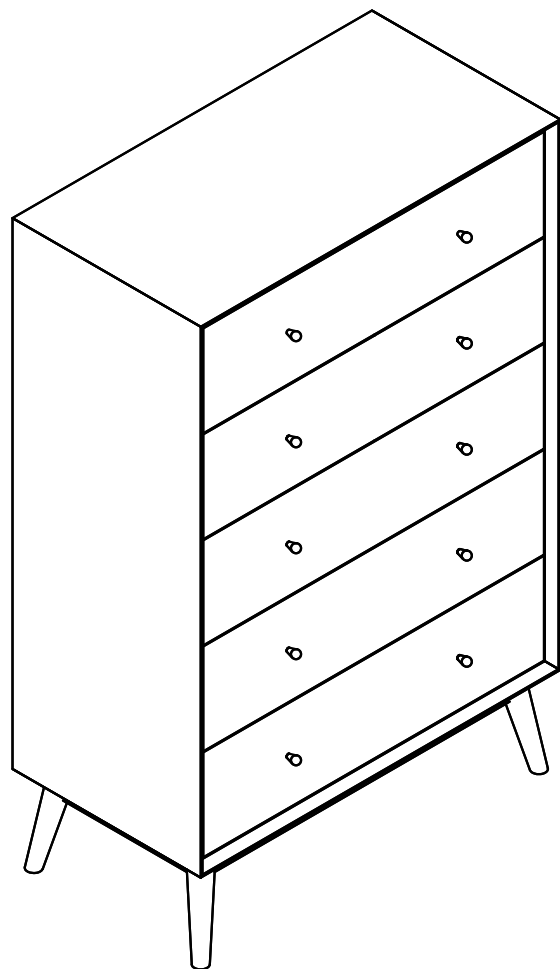
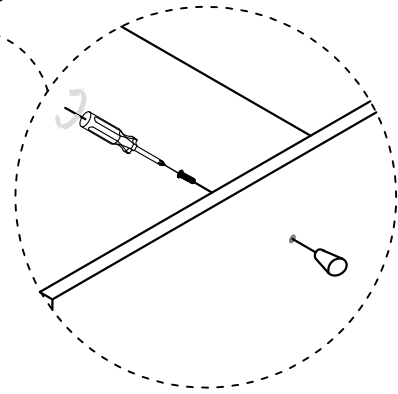
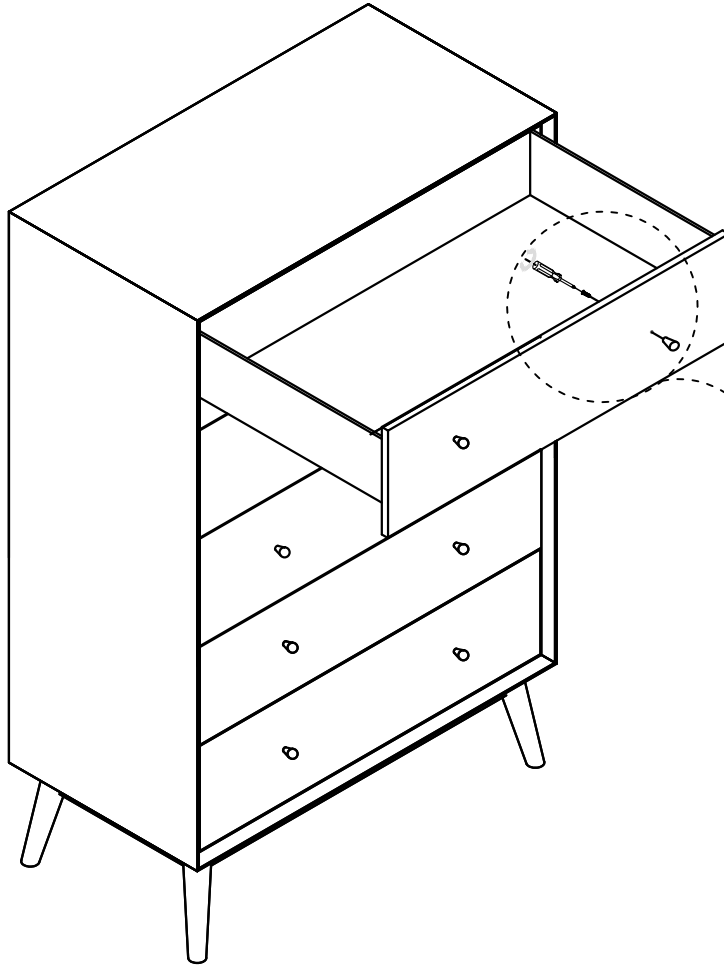
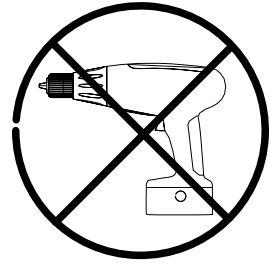

ADDITIONAL SAFETY INFORMATION

WARNING: In order to prevent overturning the wall attachment must be used with this product.

In the interest of safety, particularly where small children are concerned, we advise securing your furniture to the wall to prevent the product tipping forward when loaded.

This product is heavy and could cause serious or fatal injury if not used or moved correctly.

The screw included in the fitting pack is only intended for fixing the safety strap to the piece of furniture.

Hardware to attach the strap/s to the wall are **NOT INCLUDED**. Use fixing devices suitable for the walls in your home (not included). If you are unsure what type of fixings to use, please seek further advice from your local DIY store.

GENERAL CARE & MAINTENANCE

We advise that when cleaning the product that a damp cloth is used.

Avoid the use of all household cleaners and abrasive.

Never push or drag the furniture.

Never attempt to move the furniture when fully loaded.

We advise that periodically all fixing are re-tightened.